

A6 package: 1200V 450A IGBT module

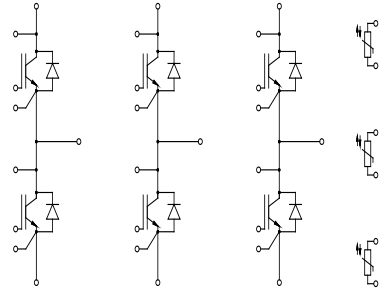
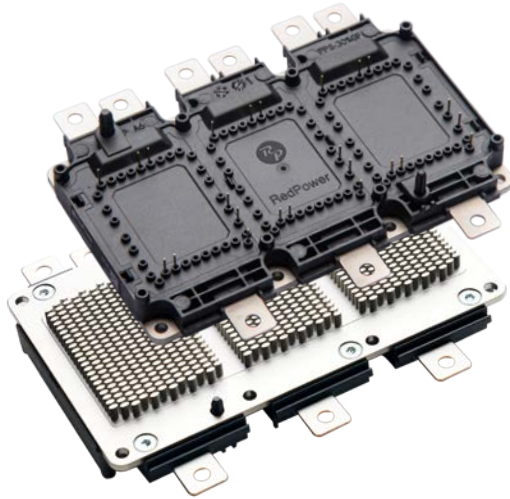

等效电路图
Equivalent Circuit Schematic

Features:

- 1200V 450A, $V_{CE(sat)} = 1.50V @ 25^{\circ}C$
- Direct cooled PinFin Base Plate
- Micro pattern trench/FS Technology
- Low switching losses

产品特性:

- 1200V 450A, $V_{CE(sat)} = 1.50V @ 25^{\circ}C$
- PinFin 直接液冷散热底板
- 微沟槽栅/场终止技术
- 低开关损耗

Typical Applications:

- Electric Vehicles
- Motor Drives

典型应用:

- 电动汽车
- 电机驱动

IGBT, Inverter / IGBT, 逆变部分

Maximum Rated Values / 最大标称参数

Collector-emitter voltage 集电极-发射极电压	$T_{vj}=25^{\circ}\text{C}$	V_{CES}	1200	V
Implemented collector current 连续集电极电流		$I_{C\text{ nom}}$	450	A
Continuous DC collector current 集电极连续直流电流	$T_F=65^{\circ}\text{C}, T_{vj\text{ max}}=175^{\circ}\text{C}$	I_C	475 ¹⁾	A
Repetitive peak collector current 集电极可重复峰值电流	$t_p=1\text{ms}$	I_{CRM}	900 ¹⁾	A
Gate-emitter peak voltage 门极-发射极峰值电压		V_{GES}	± 20	V

Characteristic Values / 性能参数

			min.	typ.	max.	
Collector-emitter saturation voltage 集电极-发射极饱和压降 ²⁾	$I_C=450\text{A}, V_{GE}=15\text{V}$	$T_{vj}=25^{\circ}\text{C}$ $T_{vj}=150^{\circ}\text{C}$ $T_{vj}=175^{\circ}\text{C}$	$V_{CE\text{ sat}}$	1.50 1.76 1.84	1.70	V
Gate threshold voltage 门极阈值电压	$V_{CE}=V_{GE}, I_C=18\text{mA}$,	$T_{vj}=25^{\circ}\text{C}$ $T_{vj}=175^{\circ}\text{C}$	$V_{GE\text{ th}}$	5.0 6.0 4.0	7.0	V
Internal gate resistor 内置门极电阻		$T_{vj}=25^{\circ}\text{C}$	$R_{G\text{ int}}$	0.7		Ω
Input capacitance 输入电容	$V_{CE}=25\text{V}, V_{GE}=0\text{V}, f=100\text{kHz}, T_{vj}=25^{\circ}\text{C}$		C_{ies}	106		nF
Reverse transfer capacitance 反向传输电容	$V_{CE}=25\text{V}, V_{GE}=0\text{V}, f=100\text{kHz}, T_{vj}=25^{\circ}\text{C}$		C_{res}	0.28		nF
Gate charge 门极电荷	$V_{GE}=-8\text{V}\sim+15\text{V}, V_{CE}=600\text{V}$		Q_G	4.28		μC
Collector-emitter cutoff current 集电极-发射极关断漏电流	$V_{CE}=1200\text{V}, V_{GE}=0\text{V}$,	$T_{vj}=25^{\circ}\text{C}$	I_{CES}		1	mA
Gate-emitter leakage current 门极-发射极漏电流	$V_{CE}=0\text{V}, V_{GE}=20\text{V}$,	$T_{vj}=25^{\circ}\text{C}$	I_{GES}		500	nA
Turn-on delay time, inductive load 开通延迟时间, 感性负载	$I_C=450\text{A}, V_{CE}=600\text{V}$ $V_{GE}=-8\text{V}/15\text{V}$ $R_{G\text{ on}}=1.43\Omega$	$T_{vj}=25^{\circ}\text{C}$ $T_{vj}=150^{\circ}\text{C}$ $T_{vj}=175^{\circ}\text{C}$	t_{don}	155 175 180		ns
Rise time, inductive load 上升时间, 感性负载	$I_C=450\text{A}, V_{CE}=600\text{V}$ $V_{GE}=-8\text{V}/15\text{V}$ $R_{G\text{ on}}=1.43\Omega$	$T_{vj}=25^{\circ}\text{C}$ $T_{vj}=150^{\circ}\text{C}$ $T_{vj}=175^{\circ}\text{C}$	t_r	55 65 70		ns
Turn-off delay time, inductive load 关断延迟时间, 感性负载	$I_C=450\text{A}, V_{CE}=600\text{V}$ $V_{GE}=-8\text{V}/15\text{V}$ $R_{G\text{ off}}=2.5\Omega$	$T_{vj}=25^{\circ}\text{C}$ $T_{vj}=150^{\circ}\text{C}$ $T_{vj}=175^{\circ}\text{C}$	t_{doff}	510 580 590		ns
Fall time, inductive load 下降时间, 感性负载	$I_C=450\text{A}, V_{CE}=600\text{V}$ $V_{GE}=-8\text{V}/15\text{V}$ $R_{G\text{ off}}=2.5\Omega$	$T_{vj}=25^{\circ}\text{C}$ $T_{vj}=150^{\circ}\text{C}$ $T_{vj}=175^{\circ}\text{C}$	t_f	125 225 245		ns
Turn-on energy loss per pulse 开通损耗	$I_C=450\text{A}, V_{CE}=600\text{V}, L_s=30\text{nH}$ $V_{GE}=-8\text{V}/15\text{V}, R_{G\text{ on}}=1.43\Omega$ $di/dt(T_{vj}=25^{\circ}\text{C})=6760\text{A/us}$ $di/dt(T_{vj}=150^{\circ}\text{C})=5450\text{A/us}$	$T_{vj}=25^{\circ}\text{C}$ $T_{vj}=150^{\circ}\text{C}$ $T_{vj}=175^{\circ}\text{C}$	E_{on}	25.5 40 43.5		mJ
Turn-off energy loss per pulse 关断损耗	$I_C=450\text{A}, V_{CE}=600\text{V}, L_s=30\text{nH}$ $V_{GE}=-8\text{V}/15\text{V}, R_{G\text{ off}}=2.5\Omega$ $dv/dt(T_{vj}=25^{\circ}\text{C})=8500\text{V/us}$ $dv/dt(T_{vj}=150^{\circ}\text{C})=6500\text{V/us}$	$T_{vj}=25^{\circ}\text{C}$ $T_{vj}=150^{\circ}\text{C}$ $T_{vj}=175^{\circ}\text{C}$	E_{off}	37 53 56.5		mJ

¹⁾非测试值, 设计计算所得

²⁾芯片标称值

SC data 短路耐量	$V_{GE}=15V/-8V$, $V_{CC}=800V$, $V_{CEmax} \leq 1200V$	$t_p \leq 8\mu s, T_{vj}=25^\circ C$ $t_p \leq 6\mu s, T_{vj}=175^\circ C$	I_{sc}		3400 2500		A
Thermal resistance, junction to cooling fluid 结-冷却液热阻	Per IGBT, $\Delta V/\Delta t=10dm^3/min$ $T_F=65^\circ C$		R_{thJF}		0.105		K/W
Temperature under switching conditions 工作温度	t_{op} continuous for 10s within a period of 30s, occurrence maximum 3000 times over lifetime		$T_{vj op}$	-40 150		150 175	$^\circ C$

Diode, Inverter / 二极管, 逆变部分

Maximum Rated Values / 最大标称参数

Repetitive peak reverse voltage 可重复反向峰值电压	$T_{vj}=25^\circ C$	V_{RRM}	1200	V
Implemented forward current 连续正向电流		$I_{F nom}$	450	A
Repetitive peak forward current 可重复正向峰值电流	$t_p=1ms$	I_{FRM}	900 ¹⁾	A

Characteristic Values / 性能参数

			min.	typ.	max.	
Forward voltage 正向通态压降 ²⁾	$I_F=450A, V_{GE}=0V$	$T_{vj}=25^\circ C$ $T_{vj}=150^\circ C$ $T_{vj}=175^\circ C$	V_F	1.95 1.92 1.82	2.40	V
Peak reverse recovery current 反向恢复峰值电流	$I_F=450A, V_R=600V$ $-di_F/dt=6600A/\mu s(T_{vj}=150^\circ C)$ $V_{GE}=-8V$	$T_{vj}=25^\circ C$ $T_{vj}=150^\circ C$ $T_{vj}=175^\circ C$	I_{RM}	345 420 435		A
Recovery charge 反向恢复电荷	$I_F=450A, V_R=600V$ $-di_F/dt=6600A/\mu s(T_{vj}=150^\circ C)$ $V_{GE}=-8V$	$T_{vj}=25^\circ C$ $T_{vj}=150^\circ C$ $T_{vj}=175^\circ C$	Q_r	20 43 49		μC
Reverse recovery energy 反向恢复损耗	$I_F=450A, V_R=600V$ $-di_F/dt=6600A/\mu s(T_{vj}=150^\circ C)$ $V_{GE}=-8V$	$T_{vj}=25^\circ C$ $T_{vj}=150^\circ C$ $T_{vj}=175^\circ C$	E_{rec}	7.2 20.2 23.0		mJ
Thermal resistance, junction to cooling fluid 结-冷却液热阻	Per FRD, $\Delta V/\Delta t=10dm^3/min$ $T_F=65^\circ C$		R_{thJF}	0.138		K/W
Temperature under switching conditions 工作温度	t_{op} continuous for 10s within a period of 30s, occurrence maximum 3000 times over lifetime		$T_{vj op}$	-40 150	150 175	$^\circ C$

¹⁾ 非测试值, 设计计算所得

²⁾ 芯片标称值

NTC-Thermistor/ NTC-热敏电阻
Characteristic Values / 性能参数

		min.	typ.	max.		
Rated resistance 标称电阻	$T_C=25^\circ\text{C}$	R_{25}	5.00			$\text{K}\Omega$
Deviation of R100 R100 偏移值	$T_C=100^\circ\text{C}$, $R_{100}=493.3\Omega$	$\Delta R/R$	-5	5		%
Power dissipation 功率耗散	$T_C=25^\circ\text{C}$	P_{25}		20		mW
B-value B 值	$R_2=R_{25} \exp[B_{25/50}(1/T_2-1/(298.15\text{K}))]$	$B_{25/50}$	3375			K
B-value B 值	$R_2=R_{25} \exp[B_{25/80}(1/T_2-1/(298.15\text{K}))]$	$B_{25/80}$	3414			K
B-value B 值	$R_2=R_{25} \exp[B_{25/100}(1/T_2-1/(298.15\text{K}))]$	$B_{25/100}$	3436			K

Module / 模块

Isolation test voltage 绝缘测试电压	RMS, $f=50\text{Hz}$, $t=1\text{min}$	V_{ISOL}	3.0			KV
Material of module baseplate 模块底板材料			Cu+Ni ¹⁾			
Internal isolation 内部绝缘			ZTA			
Creepage distance 爬电距离	Terminal to heatsink Terminal to terminal	d_{Creep}	9.0 9.0			mm
Clearance 电气间隙	Terminal to heatsink Terminal to terminal	d_{Clear}	4.5 4.5			mm
Comparative tracking index 相对漏电起痕指数		CTI	200 ²⁾			

min. typ. max.

Stray inductance module 模块杂散电感		L_{sCE}	9.5			nH
Module lead resistance, terminals-chip 模块引脚电阻, 端子-芯片	$T_C=25^\circ\text{C}$, Per switch	$R_{\text{CC}'+\text{EE}'}$	0.75			m Ω
Storage temperature 贮存温度		T_{stg}	-40		125	$^\circ\text{C}$
Mounting torque for module mounting 模块安装力矩	Baseplate to heatsink, Screw M4	M	1.8		2.2	Nm
	Terminal connection, Screw M5		3.6		4.4	
	PCB to frame		0.5		0.6	
Weight 重量		G	760			g

¹⁾ 铜底板表面镀镍

²⁾ CTI 约为 200

Circuit Diagram / 曲线图

Output characteristic , Inverter IGBT (typical)

输出特性, 逆变IGBT (典型)

$I_C=f(V_{CE})$, $V_{GE}=15V$ (Inclusive R_{CC+EE})

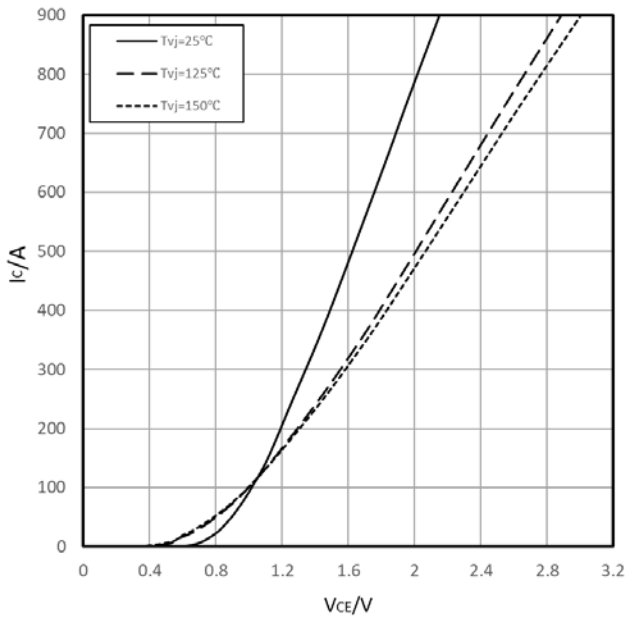

Output characteristic , Inverter IGBT (typical)

输出特性, 逆变IGBT (典型)

$I_C=f(V_{CE})$, $T_{vj}=150^{\circ}C$

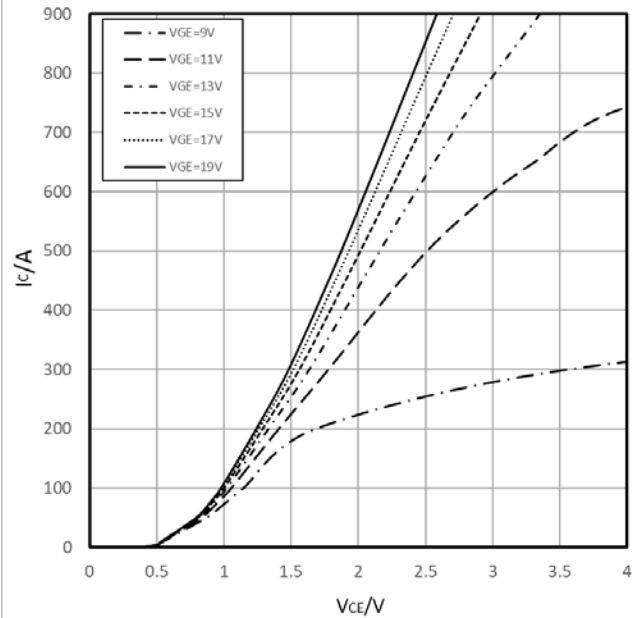

Transfer characteristic , Inverter IGBT (typical)

传输特性, 逆变IGBT (典型)

$I_C=f(V_{GE})$, $V_{CE}=20V$

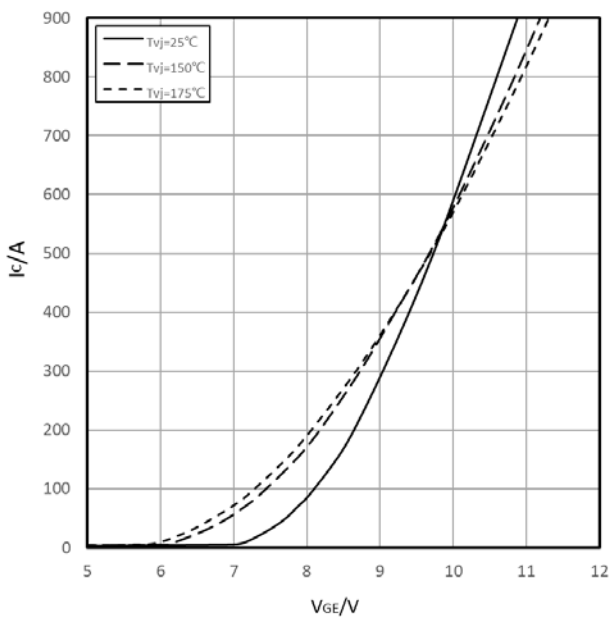

Switching losses , Inverter IGBT (typical)

开关损耗, 逆变IGBT (典型)

$E_{on}=f(I_C)$, $E_{off}=f(I_C)$

$V_{GE}=+15V/-8V$, $R_{gon}=1.43\Omega$, $R_{goff}=5.0\Omega$, $V_{CE}=600V$

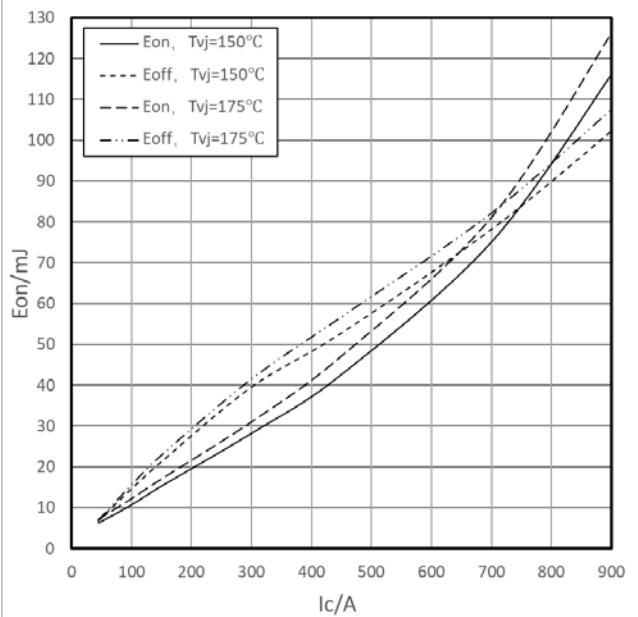

Switching losses , Inverter IGBT (typical)
开关损耗, 逆变IGBT (典型)

$E_{on}=f(R_g)$, $E_{off}=f(R_g)$
 $V_{GE}=+15V/-8V$, $I_C=450A$, $V_{CE}=600V$

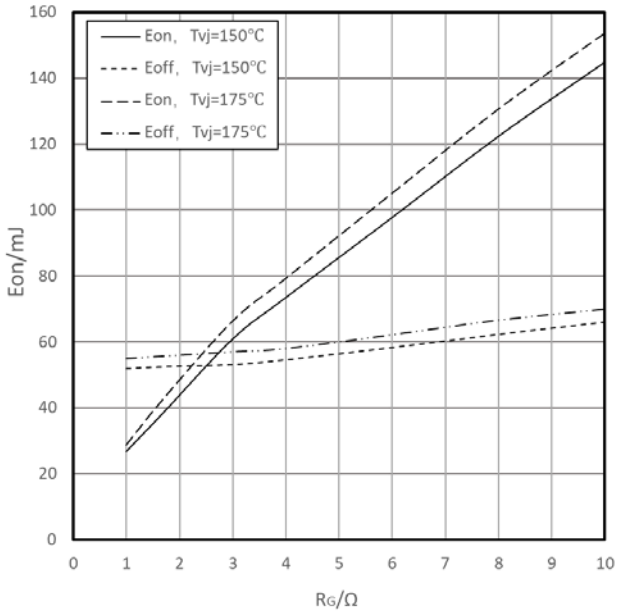

Transient thermal impedance IGBT, Inverter
瞬态热阻, 逆变IGBT

$Z_{thJF}=f(t)$
 $\Delta V/\Delta t=10dm^3/min$; $T_f=65^\circ C$; 50% water/50% ethylenglycol

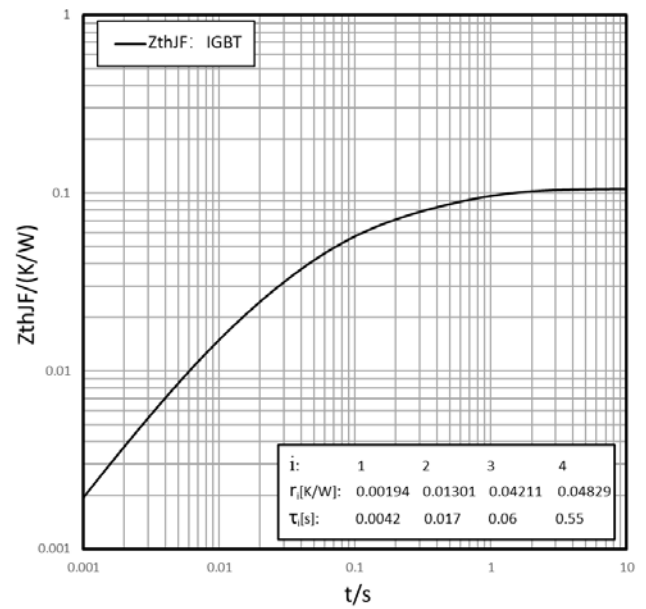

Reverse bias safe operating area , Inverter IGBT (RBSOA)
反偏安全工作区, 逆变IGBT (RBSOA)

$I_C=f(V_{CE})$, $V_{GE}=+15V/-8V$, $R_{goff}=5.0\Omega$, $T_{vj}=150^\circ C$

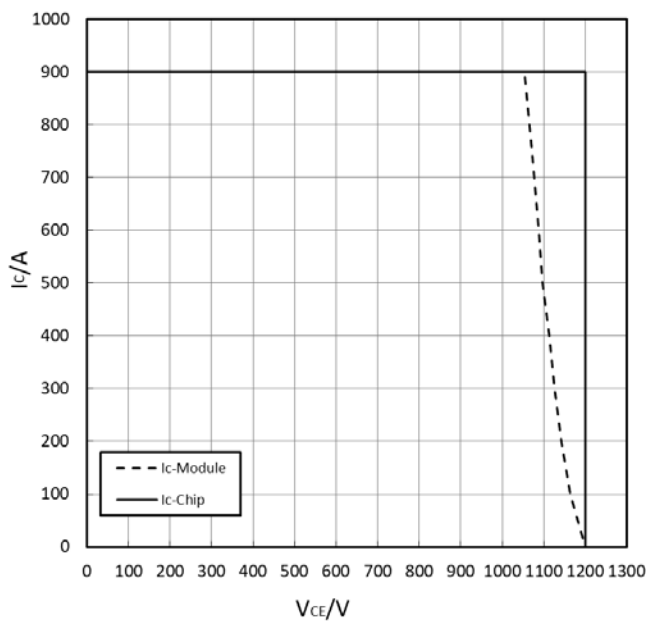

Forward characteristic , Inverter FRD (typical)
正向偏压特性, 逆变FRD (典型)

$I_f=f(V_f)$ (Inclusive $R_{CC'+EE'}$)

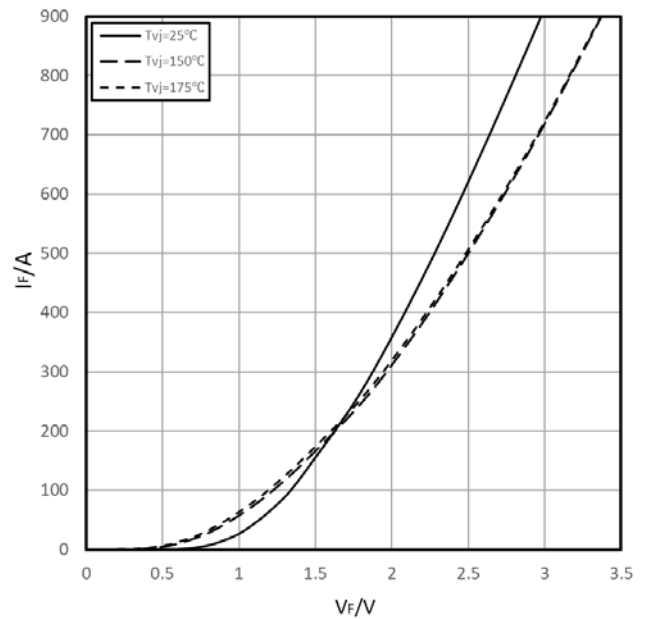

Switching losses , Inverter IGBT (typical)

开关损耗, 逆变FRD (典型)

$$E_{rec}=f(I_F), R_{gon}=1.43\Omega, V_{CE}=600V$$

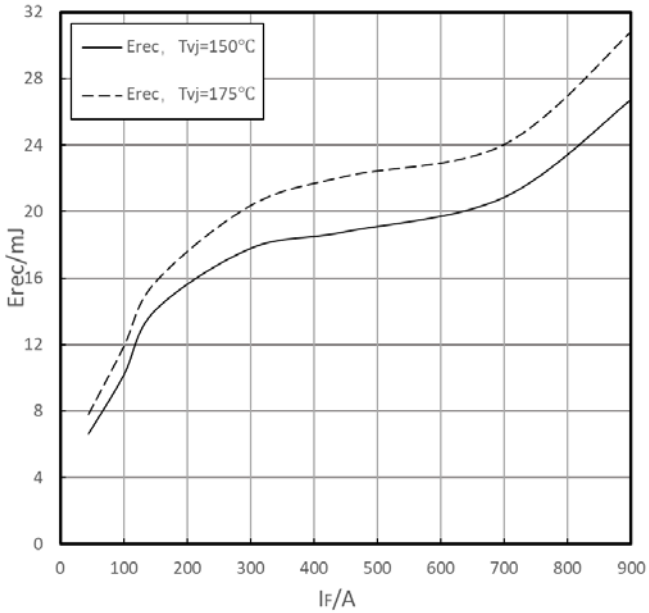
Switching losses , Inverter FRD (typical)

开关损耗, 逆变FRD (典型)

$$E_{rec}=f(R_G), I_F=450A, V_{CE}=600V$$

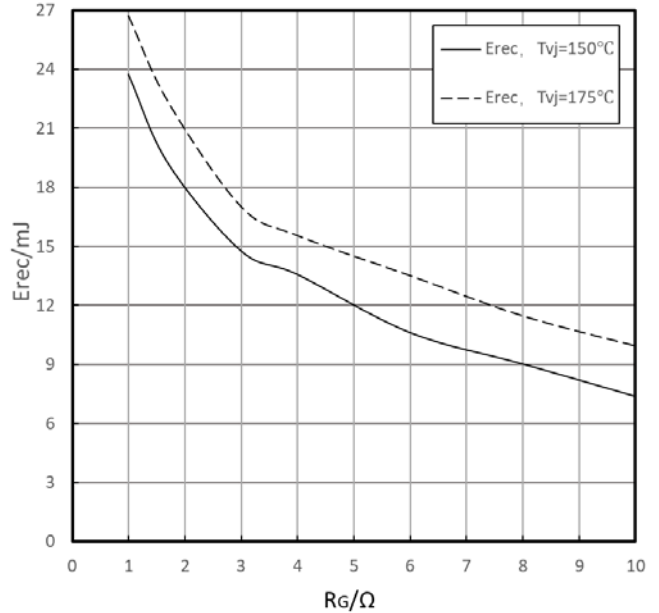
Transient thermal impedance FRD, Inverter

瞬态热阻, 逆变FRD

$$Z_{thJF}=f(t)$$

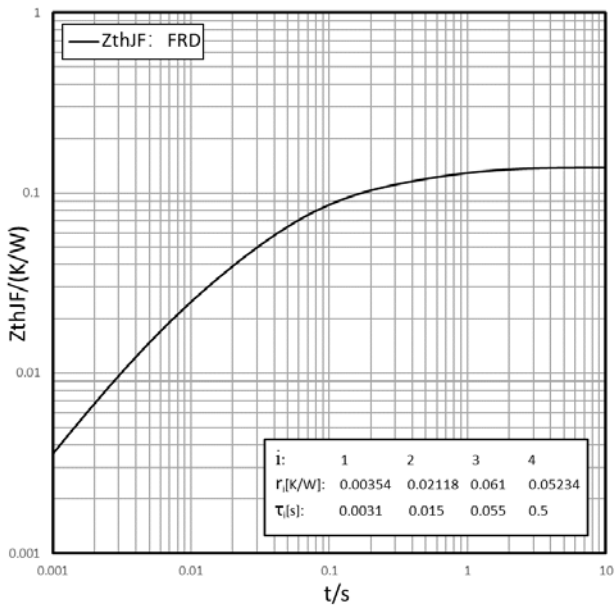
 $\Delta V/\Delta t=10dm^3/min$; $T_f=65^\circ C$; 50% water/50% ethylenglycol

NTC-Thermistor-temperature characteristic

负温度系数热敏电阻 温度特性

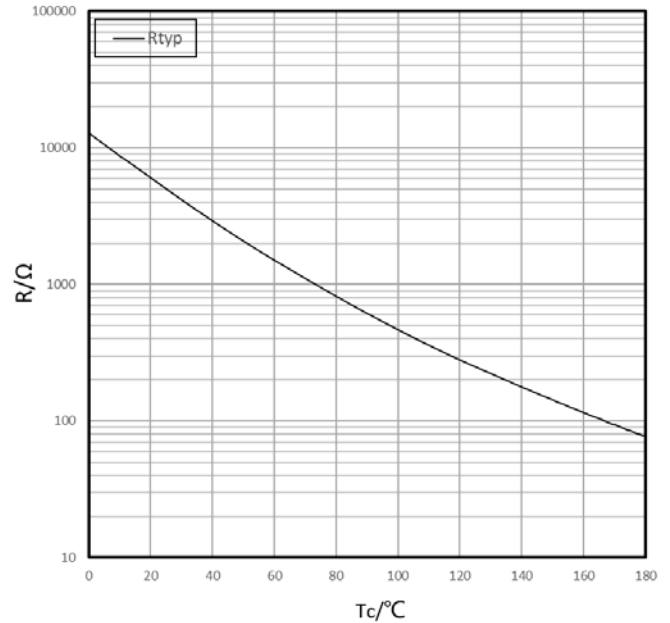
$$R=f(T)$$

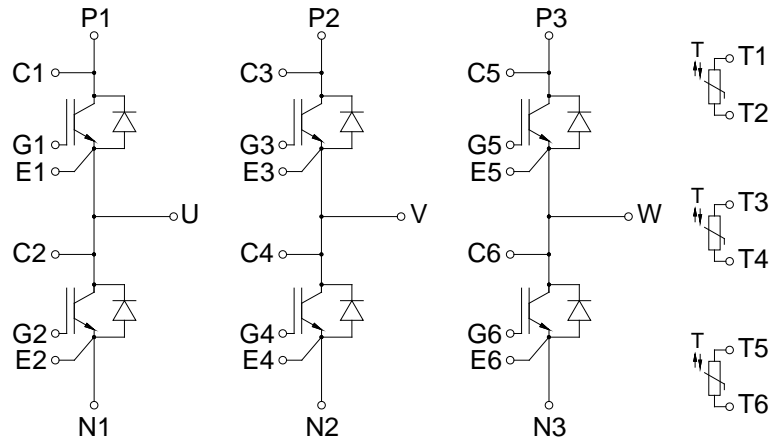

Internal Circuit / 内部电路



Package Dimension / 封装尺寸

Dimensions in Millimeters / 毫米为单位

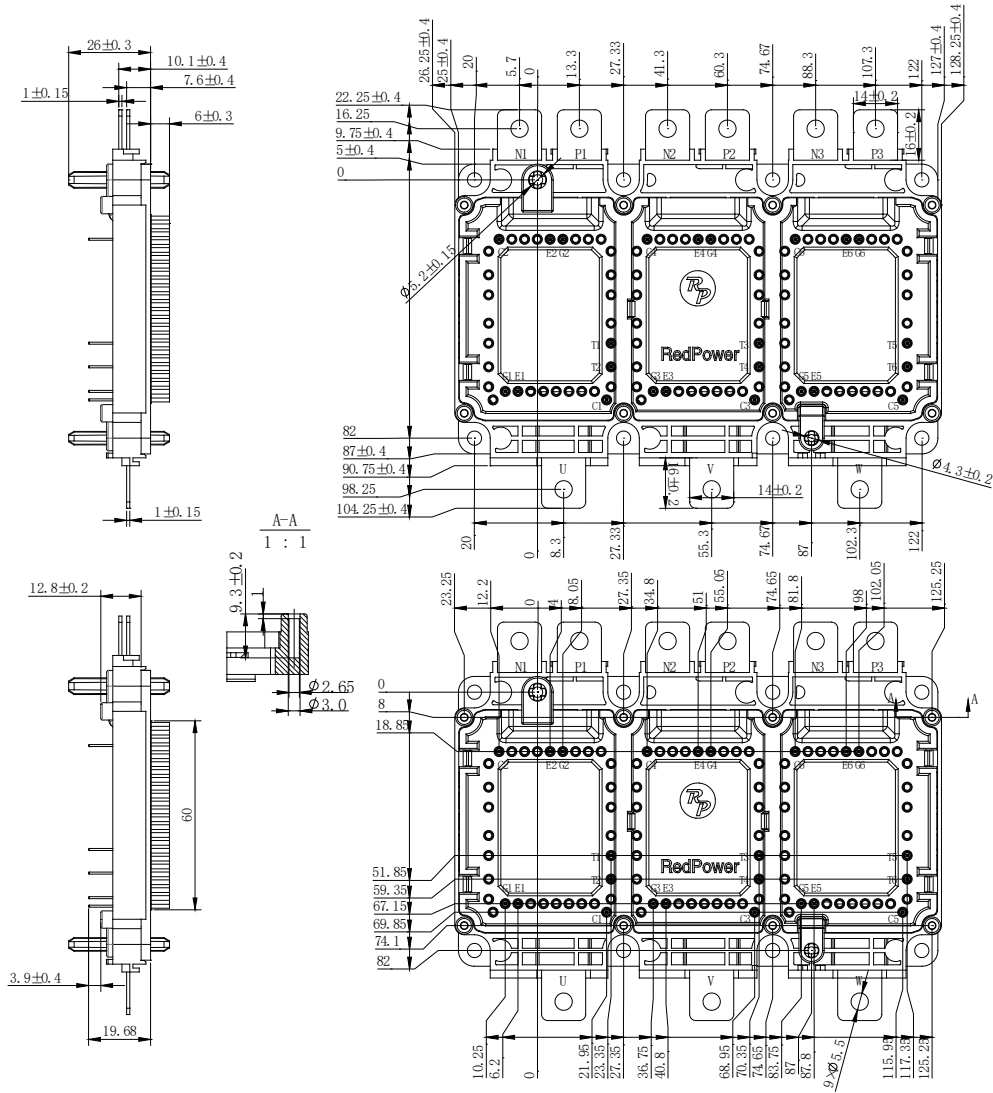

Change Record / 变更记录